

**WATERPROOF
CONDUCTIVITY / SALINITY METER**

CC-401

USER'S MANUAL

USER'S MANUAL

WATERPROOF
CONDUCTIVITY / SALINITY METER CC-401

Before use please read the instruction carefully.

CONTENTS

I. INTRODUCTION	1
1. Exploitation notices	3
2. Characteristics of the meter	4
3. What is the meter designed for	5
4. The outside view	6
5. Switching the meter on and off	9
6. Preparation to work	10
6.1. Choosing the kind of temperature compensation	10
6.2. Changing the resolution of measurements	11
6.3. Changing the cell number	12
6.4. Readout of the date of last calibration	13
6.5. Introduction of the time of calibration validity	14
II. CONDUCTIVITY AND SALINITY MEASUREMENT	15
7. Basic information about the conductivity measurement	17
8. Entering parameters of the conductivity	18
8.1. Choosing the unit	18
8.2. Entering the W_{TDS} coefficient	20
8.3. Entering the α coefficient value	21
8.4. Entering the reference temperature value	22
9. Choosing and maintaining the conductivity cell	23
9.1. Choosing the cell	23
9.2. Maintaining the conductivity cell	24
10. Calibration	25
10.1. Calibration without standard solution	25
10.2. Calibration with use of standard solution	26
11. Conductivity measurement	30
11.1. Measurement without temperature compensation	30
11.2. Measurement with automatic temperature compensation	31
11.3. Measurement with manual temperature compensation	32
12. Salinity and total dissolved solids measurement	33
12.1. Salinity measurement with conversion to NaCl or KCl	34
12.2. Determining the W_{TDS} coefficient	35
12.3. Salinity measurement with conversion to TDS	35
13. Simplified way of determining the α coefficient	36
III. TEMPERATURE MEASUREMENT	39
14. Temperature measurement	41
IV. OTHER	43
15. Clock with date	45
15.1. Clock	45
15.2. Date	45
15.3. Setting time and date	45
15.4. Auto switch off function	46
15.5. The LCD backlight mode	47

15.6. The brightness control	47
15.7. Readout of the software version number	48
16. Storing and readout of the results	49
16.1. Parameters of storage and readout from the memory	49
16.2. Memorising single readouts	51
16.3. Collecting measuring series	51
16.4. Reviewing the results	52
16.5. Deleting stored results	52
17. Power, replacing the rechargeable battery	53
18. Co-operation with a PC	54
19. Technical data	55
20. Equipment	56

I. INTRODUCTION

1. EXPLOITATION NOTICES

Dear User!

We present you a device distinguished by accuracy according to the technical data and by high stability of the displayed results. We believe that the measurements will not cause you any trouble and that the meter will operate without any inconvenience. **Wide range of additional functions requires careful reading of the manual, in other case some of the features may stay unused or using the meter may be troublesome.**

Using cells of good quality and keeping them clean ensures obtaining high measuring accuracy. It is important to choose the cell with a K constant value suitable for the measuring range. Improper selection may cause larger error occurrence, what may also happen during measurements with automatic temperature compensation with an inappropriate α coefficient introduced.

Infrequent failures are the essential feature of our products. However, in case of failure, our firm performs its warranty repair immediately.

We wish you a pleasant and trouble-free work with our meter.

2. CHARACTERISTICS OF THE METER

The conductivity meter **CC-401** belongs to the newest generation of measuring devices. It offers wide range of additional functions. The meter ensures high accuracy and repeatability of the readings. Two kinds of power source: rechargeable battery and power adapter enable work in field and long-lasting measurements in the laboratory. The meter's memory is independent from power supply. The meter is equipped with large backlit custom LCD display, enabling simultaneous observing of the measured function, temperature value and additional symbols which make working easier. Waterproof housing makes working in difficult conditions possible. Minimised size and weight make the meter very handy especially during the field work.

Main features of **CC-401** are:

- high accuracy and stability of readings;
- automatic and manual temperature compensation;
- storing of the date and calibration characteristics of three conductivity sensors;
- wide range of conductivity measurement with 7 automatically switched subranges (autorange);
- counting the conductivity to salinity in NaCl or KCl according to actual dependence to conductivity;
- possibility of introducing the TDS coefficient;
- calibration of the conductivity cell by introducing the K constant or in standard solutions;
- function of determining the K constant of the cell;
- possibility of introducing the time of calibration validity and signalling its expiry;
- storing results with time date and temperature, taken in series or as single measurements with set time interval;
- RS-232 output with a possibility of connecting the USB adapter;
- large LCD backlit display with brightness control;
- real time clock with date;
- automatic switch off function after time set by the user.

3. WHAT IS THE METER DESIGNED FOR

Waterproof conductivity meter **CC-401** is precise and easy-to-use meter designed for conductivity measurements in $\mu\text{S}/\text{cm}$ or mS/cm . The meter may be also used for accurate temperature measurement of solutions and air in $^{\circ}\text{C}$.

The conductivity measurement result may be also displayed in concentration units (g/l or %) counted to NaCl, KCl or TDS. Waterproof housing enables work in difficult weather conditions or in humid environment.

The **CC-401** conductivity meter is used in food, chemical, pharmaceutical and power industries, in water treatment stations, laboratories, agriculture, universities, scientific laboratories etc.

The meter is prepared to work with conductivity cells with wide K constant range, equipped with BNC-50 connector.

CC-401 co-operates with Pt-1000 temperature probe with Chinch connector.

The meter may store results taken as single or series of measurements with set time interval. RS-232 output enables connecting the meter with a PC for sending the stored data or current results of the measurement. There is a possibility of connecting the meter with a PC using a special RS-232/USB converter. In case of necessity of collecting series exceeding the memory capacity it is possible to use a special software offered by our company (an optional equipment).

Caution: RS-232/USB converter and a special software for collecting series of measurements on a PC is offered as an additional equipment.

4. THE OUTSIDE VIEW



On the front wall of the meter there is an LCD display situated (pic. 1), on which - depending on the chosen function - the following symbols are displayed:

- result of the conductivity or salinity measurement;
- time and date.

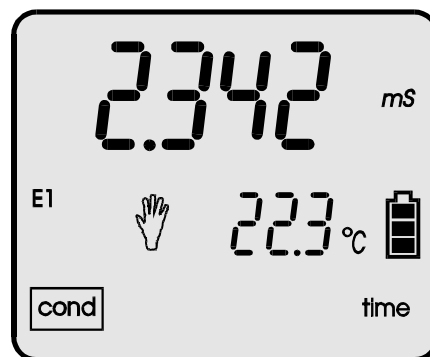
Choosing the function by the  button is signalled by the frame displayed around the symbol of the chosen function in the lower part of the display: **cond** (conductivity) or **time**. Simultaneously with the result a measured temperature value in °C is displayed. Symbols of the units are displayed next to the results.



Pic. 1.

Beside the temperature value the  symbol for automatic temperature compensation or the  for manual compensation is displayed. The **CAL** symbol on the left side of the display informs that the meter is in calibration mode.

The number of the chosen cell is displayed on the left side (E1, E2, E3). It informs which of the characteristics will be taken into consideration during all calculations. Blinking symbol of the number of the cell informs that the characteristic was deleted or that the calibration validity has expired (point 6.5). With use of MODE, all parameters introduced by the user are displayed. The rechargeable battery condition is signalled by the  symbol.

The keyboard (Pic. 2) placed under the display is used for switching the meter on and off, choosing the measuring function, calibration, entering the parameters and storing the results in the memory.

The keyboard has the following keys:



- pressing switches the meter on, enables changing the function, pressing and holding switches the meter off;



- pressing and holding enters the calibration mode (the *CAL* symbol displayed). Short pressing in this mode confirms the calibration result;



- after pressing this button the result is stored or the measuring series starts;

- after pressing and holding this button, it is possible to review stored results;



- chooses the entered parameter;



- buttons used for entering parameters.

In the upper wall of the meter there are inputs placed with the symbols given below:

F1 - **BNC-50** connector for the conductivity cell;

t - **Chinch** input to connect the temperature probe;

RS - **RS-232** input for connecting with a PC;

P - power adapter input.

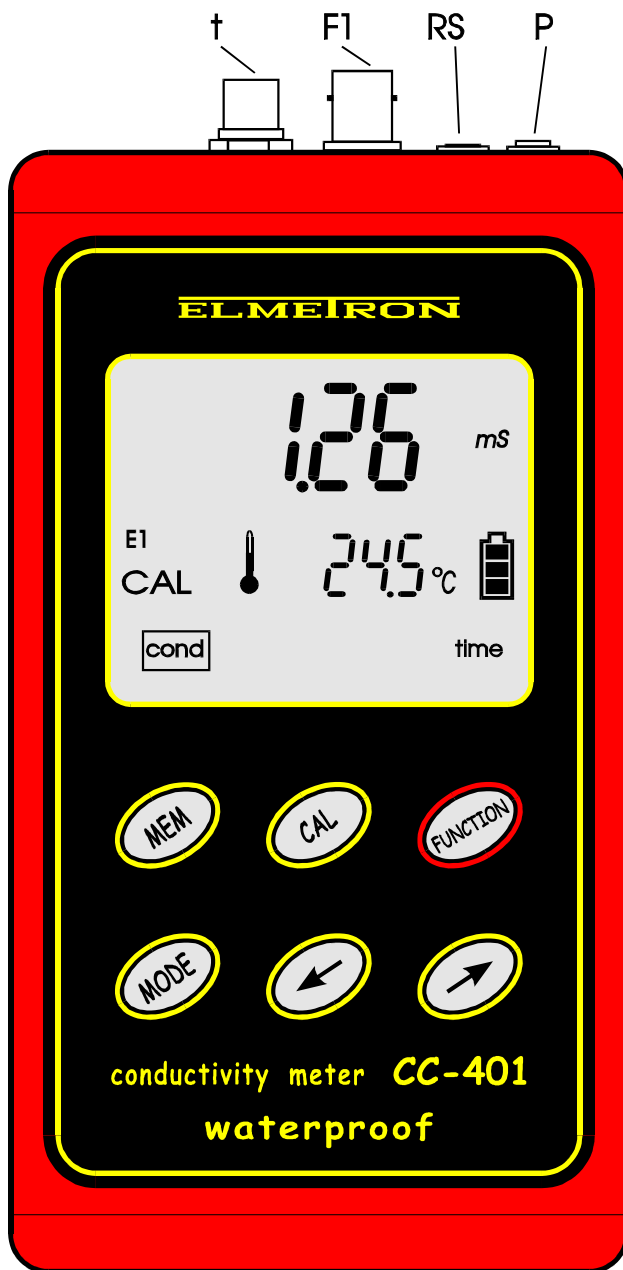

Pic. 2.

5. SWITCHING THE METER ON AND OFF

After switching it on with the  button, the meter tests the memory and the display on which all symbols are displayed (Pic. 3).

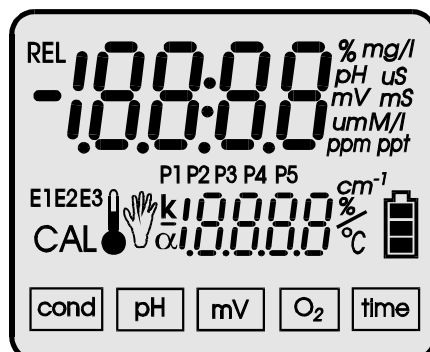

Pic. 3.

If the test ends successfully, after about 1.5 s the meter switches automatically to the measuring mode, in which it was switched off. If the *HELP* sign is displayed it means that the meter has lost the factory settings and requires service repair. If after 1,5 s all symbols are continuously displayed it informs that the calibration parameters of electrodes or cells have been lost.

After pressing  the meter adopts standard constant $K = 1.000 \text{ cm}^{-1}$ for conductivity cell and enters the measuring mode. It is necessary to calibrate the conductivity cell (it is recommended to introduce the K constant given by the manufacturer).





The meter is switched off by pressing and holding the  button till the *OFF* symbol displays. To save the rechargeable batteries, the meter switches automatically off after the time of non-use set by the user (description in the chapter 15.4). This function is switched off during calibration, while collecting series of measurements and working with power adapter.

6. PREPARATION TO WORK

Before starting work:



- connect the power adapter plug to the **P** input, if work with the power adapter is intended;
- connect the appropriate conductivity cell to **F1** input (BNC-50);
- in case of using the temperature probe connect it to the chinch temperature input **t**;
- in case of working with a PC connect the 4XX-PC cable to the **RS** input;
- switch the meter on by pressing .

6.1. Choosing the kind of temperature compensation

The meter switches to the automatic or manual temperature compensation mode itself. Connecting the temperature probe switches the automatic temperature compensation on. Next to the measured value the  symbol is displayed. After disconnecting the probe the meter enters the manual temperature compensation mode. In place of the  symbol the  is displayed, at the same time the buttons  ,  are being unlocked and changing the temperature using them is possible.

6.2. Changing the resolution of measurements

The measurement results may be displayed with a chosen resolution.
Setting the resolution:

- in the measuring mode press , the *rES* (resolution) sign will be displayed. (Pic. 4)
- using the keys , , choose:
 - Lo* - low resolution of the measurement;
 - Hi* - high resolution of the measurement.

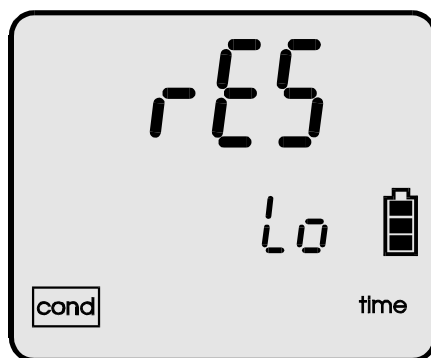

Pic. 4.



Lo - resolution of the measurement 3½ digits;
Hi - resolution of the measurement 4½ digits.

Return to the measuring mode by pressing the  button.

6.3. Changing the cell number

If there is more than one cell's characteristic stored in the meter's memory, it is possible to replace the cells without the need of calibration. This option is quite useful in case of working with cells having different constants K. It is necessary to connect the cell calibrated earlier, marked with the number which responds to the number stored in the memory and choose this number.

In order to do so, in the measuring mode:

- press the  button till the moment of displaying the $E1$, $E2$ or $E3$ symbol in the upper row of the display, than using the ,  buttons choose the cell number. The calibration results will be stored under the chosen number (pic. 5). Below the cell number one of the following signs will be displayed:

Clr - under this number there is no characteristic stored and the producer's values are provided. In the measuring mode the cell number will be flashing.

Set - under this number there are values of last calibration stored.

Additionally the points in which the cell was calibrated are shown under the cell number.

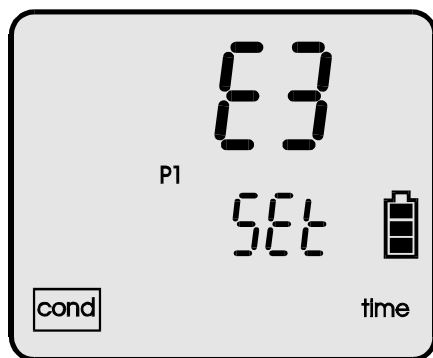

Pic. 5.





- return to the measuring mode by pressing the  button.

Caution: while changing the conductivity cell one should remember about choosing the proper cell number in the meter.

6.4. Readout of the date of last calibration

The meter remembers the dates of calibration of all cells. Before starting work it is possible to check the date of last calibration.

In order to do so, in the measuring mode:

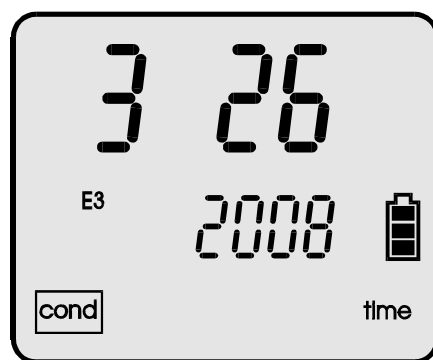

- press the  button till the moment of displaying the cell number in the upper row of the display (E1, E2 or E3 symbol);
- using the ,  buttons choose the cell number you want to check and press the  button shortly. The date of the last calibration will be displayed in the following format: month – day and the year will be displayed below (Pic.6). On the left side of the display the cell number is shown.

Flashing date informs about expiration of the cell's calibration validity. Introducing the calibration time is described in the point 6.5.



Pic. 6.





The meter memorises the date during calibration. If the date in the meter's clock is changed after calibration, the date of calibration validity expiration will be faulty signalled. It is important to set the correct date before calibration.

Return to the readout of the cell number mode by pressing the  button, and to the measuring mode by pressing the  button.

6.5. Introduction of the time of calibration validity

The meter remembers the time of calibration validity separately for each cell. After this time has been exceeded, the meter signals on the display with flashing number of electrode (E_1 , E_2 or E_3 symbols) that the calibration for this electrode or sensor is necessary.

To enter the time validity of the calibration in the measuring mode of the chosen function:

- press the  button till the moment of displaying the t_{out} symbol (time out) in the upper row of the display. The number of days to the next calibration will be displayed below (Pic. 7.);
- using the  ,  buttons enter the demanded quantity of days to the next calibration. After choosing time of one day and pressing the  button, instead of digital values the --- symbol appears and the function of reminding about next calibration is blocked.

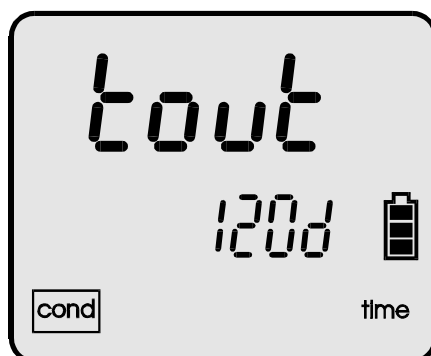

Pic. 7.

Return to the measuring mode by pressing the  button.

II. CONDUCTIVITY AND SALINITY MEASUREMENT

7. BASIC INFORMATION ABOUT THE CONDUCTIVITY MEASUREMENT



The conductivity measurement is based on applying electric current with a proper voltage and frequency to the measured solution. In **CC-401** the voltage comes to several dozens of mV and the frequency depends on the measuring range and may vary from 100 Hz up to 10 kHz. The electric current value is dependent on the kind of the measured liquid, its concentration and temperature. The conductivity result indirectly informs about the salt concentration in the measured liquid – when it increases, the conductivity rises (KCl, NaCl). However, this dependence doesn't concern all of the solutions. In some of them, after overdrawing certain salinity value the conductivity starts decreasing. The value of a conductivity measurement also increases together with the temperature. Measured conductivity can be displayed as salinity in g/l of NaCl or KCl assuming that the measured liquid includes homogeneous salt. There is a possibility to define approximately the concentration of salt dissolved in water on the basis of the TDS coefficient. The electrodes' surface and the distance between them are decisive factors for the cell's K constant value. This value has a great influence on the accuracy of the measurement. Depending on the measured conductivity value, cells with K constant = $0,1 \text{ cm}^{-1}$ up to 10 cm^{-1} are used. During measurement the meter multiplies the measured value by the K constant introduced to the meter's memory and displays the result in units of **conductivity** ($\mu\text{S}/\text{cm}$ or mS/cm). The unit symbol in abbreviated form (μS or mS) is displayed next to the result. Conductivity changes along with temperature and salts concentration. In order to enable comparison of the results, the measured value is counted by the meter to the value which corresponds to measurement in reference temperature (it is usually the temperature 25°C). Measurement in reference temperature is the most accurate. In other temperatures the temperature compensation is used, which means that the meter calculates the influence of the temperature and α coefficient (this value should be entered by the user before making measurement, section 8.3) on the result. This coefficient describes how much (in %) the result changes by 1°C of the temperature change. The α coefficient may be introduced into the meter in $0 \div 10.00\% / ^\circ\text{C}$ range. For NaCl in temperatures close to 25°C it amounts to $2\% / ^\circ\text{C}$, e.g., in case of measurements in 30°C the result change totals to $5 \times 2\% = 10\%$. Counting is made automatically and takes into consideration the value of the α coefficient introduced by the user. This value can be found in appropriate resources or approximated by the user (chapter 13). The conductivity measurement should always be treated as burdened with a certain error, which depends on the conductivity cell (its linearity) and temperature. When measurements are not made in the reference temperature, the error is dependent mainly on the α coefficient, which is affected by the temperature and concentration changes.

8. ENTERING PARAMETERS OF THE CONDUCTIVITY

Before starting calibration and measurements it is necessary to perform all activities described in the chapter 6. Additionally, according to the chapter below, it is necessary to choose the unit of calibration and measurement.

8.1. Choosing the unit

The result of the measurement is displayed in units of conductivity or salinity. Salinity can be counted to NaCl, KCl or TDS content. The result can be displayed in % of **weight concentration** or in **g/l**. To choose the unit:

- in the conductivity measuring mode press  till a **Unit** (unit) symbol displays in the lower row on the LCD;
- with  ,  buttons choose in the lower row on the LCD:

Cond - measurement in units of conductivity (pic. 8);

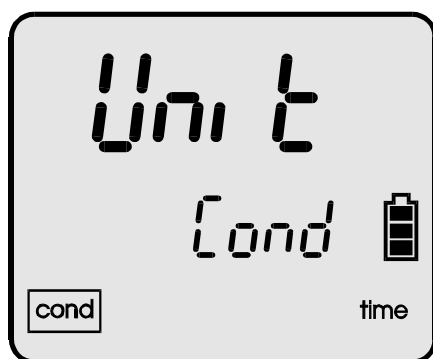

Pic. 8.

NaCl - measurement result counted to NaCl in **g/l** (pic. 9);

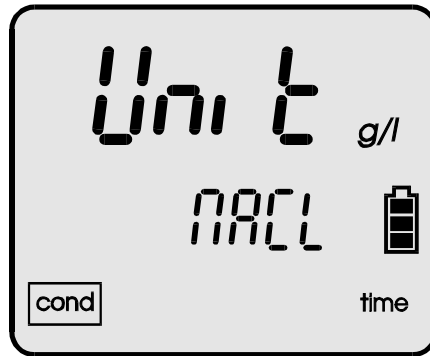

Pic. 9.

KCl - measurement result counted to KCl in **g/l** (pic. 10);

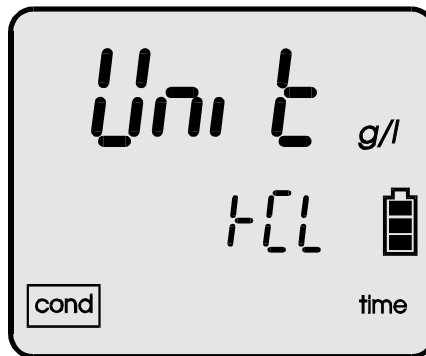

Pic. 10.

TDS - measurement result counted to TDS in **g/l** (pic. 11).

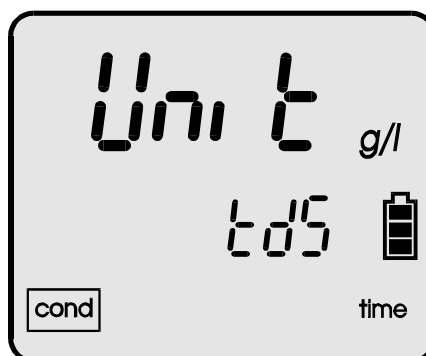

Pic. 11.

In case of salinity measurement (*NaCl*, *KCl* or *CaCl₂*) short press of the  button chooses displaying the result in % of weight concentration or g/l. Next to the *Unit* a % or g/l symbol will be displayed.

- enter the measuring mode by pressing the  button.





The result of measurement in % of weight concentration may be counted to value in **ppm** according to the dependence:

$$1\% \text{ of weight concentration (C)} = 10\,000 \text{ ppm} = 10 \text{ ppt}$$

Resolution of measurement in % of weight concentration is 0.001% or 10 ppm.

8.2. Entering the W_{TDS} coefficient

In case of measurement of salinity with conversion to TDS it is necessary to introduce the W_{TDS} coefficient:

- in the conductivity measuring mode press the  button a few times till a *ctd5* symbol (TDS coefficient) displays in the upper row on the LCD (pic. 12);
- with the  ,  buttons enter the appropriate value of the TDS coefficient;
- enter the measuring mode by pressing the  button.

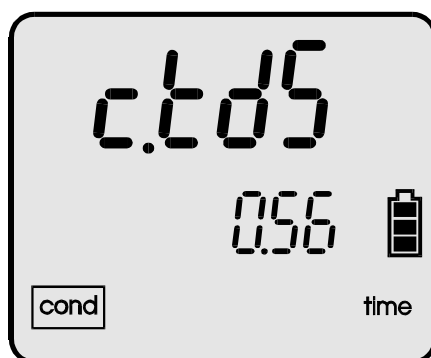

Pic. 12.

The way of determining the W_{TDS} coefficient is described in the section 12.2.

8.3. Entering the α coefficient value

The α coefficient in **CC-401** has $0 \div 10.00$ % range with accuracy of regulation 0.01 % / $^{\circ}\text{C}$. For measurements it is possible to adopt the most often used temperature coefficient $\alpha = 2$ % / $^{\circ}\text{C}$ or in case of higher accuracy requirements to determine the kind of measured solution and choose the appropriate value of this coefficient.

To introduce the α coefficient:

- in the conductivity measuring mode press the **MODE** button till the screen with a value of the α coefficient with a **t.cof** (temperature coefficient α) symbol displays (pic. 13);
- with **←** , **→** buttons enter the value of the coefficient;
- return to the measuring mode by pressing the **FUNCTION** button.

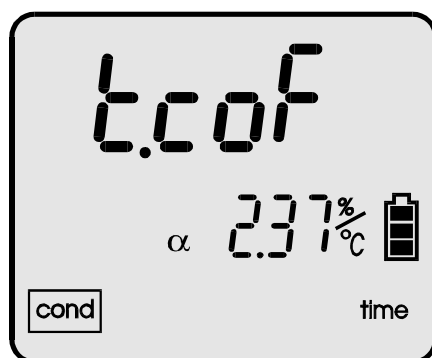

Pic. 13.





The measurement result will be counted with use of the introduced temperature coefficient α .

Simplified way of determining the α coefficient is described in the section 13.

8.4. Entering the reference temperature value

The reference temperature values are introduced in 10.0 ÷ 40.0 °C range with a possibility of setting with accuracy of 0.1 °C. The most often used value is 25 °C.

In order to introduce the reference temperature value:

- in the conductivity measuring mode press and hold the  button till a screen with a value of the reference temperature and the *t.ref* sign (temperature reference) displays (pic.14).;
- with the  ,  buttons introduce the temperature value;
- return to the measuring mode by pressing the  button.

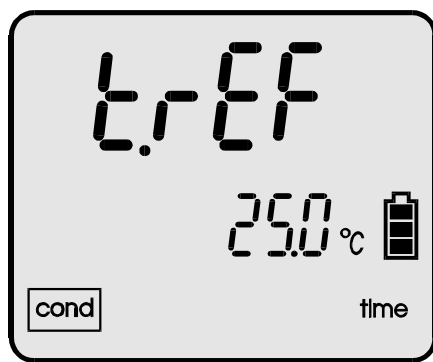

Pic.14.

The measurement result will be calculated to the introduced reference temperature.

Caution: pressing both  ,  buttons simultaneously sets the temperature to 25 °C.

9. CHOOSING AND MAINTAINING THE CONDUCTIVITY CELL

9.1. Choosing the cell

Conductivity in the **CC-401** meter can be measured in 0 – 1999 mS/cm range. The meter co-operates with conductivity cells with K constant = $0.010 \div 19.99 \text{ cm}^{-1}$ and BNC-50 connector. Depending on the required measuring range it is necessary to choose the cell with a K constant which enables receiving appropriate results. **In case of measurement made beyond the cell's range it loses linearity and the results are burdened with an increasing error.** Accurate measurements in the whole range are possible when using 3 different conductivity cells.

Depending on the expected measuring range proper cell may be chosen with use of the following chart.

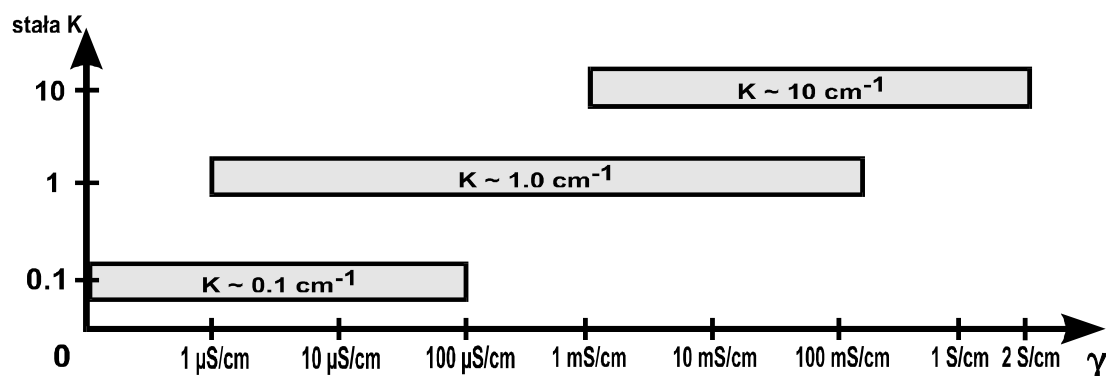

Pic. 15. Dependence between the measuring range and K constant of the applied conductivity cells.

The cell with a $\approx 0,1 \text{ cm}^{-1}$ should be used for measurements of ultra pure and distilled water, which changes conductivity after contact with air very quickly, therefore pouring it into vessels for measurement with a submersible cell may cause errors. For accurate measurements of such low concentration it is necessary to use flow-through cell with built-in temperature probe, what enables measurement of water which flows directly from the container.

9.2. Maintaining the conductivity cell

In order to receive stable results it is advisable to store the cell in water for a few hours before measurement, especially in case of measurements in distilled water.

Maintenance of the conductivity cell consists mainly in washing the inside of the measuring cell accurately with distilled water. The platinum electrodes **must not be cleaned mechanically**, because this results in rubbing off the platinum layer, what can cause decreasing of accuracy, lowering of stability and changing of the K constant.

Measurements of liquids with oils and heavy sediment content may cause platinum contamination, make the measurement impossible and irreparably damage the electrodes. In case of fat content in the measured liquids it is possible to clean the electrodes by immersing the cell in acetone, chloroform, tetrahydrofuran or detergent.

Certain norms propose universal liquid for cleaning cells. This is a mixture of equal parts of isopropyl alcohol, ethyl ether and hydrochloric acid diluted with water in 1:1 ratio.

Breaking of the measuring cell hinders any further measurements due to significant change of the K constant, unstable results and increase of the dependence of the result on the position of the cell in the measuring vessel.

The cell should be immersed in such a way for the solution to fill it up and not to include any air bubbles (single bubbles or silver coating). It is essential for obtaining accurate results of measurements. The best way is to immerse the cell, make a few vertical moves and thus to remove air bubbles through holes in the upper part of the cell. If the air bubbles appear each time after the cell has been immersed and they are difficult to remove, it is advisable to immerse the cell in a water – washing up liquid mixture, what will lower the surface tension and disable air bubbles to stick to the surface of the cell walls or electrodes. After such action the cell should be washed accurately in distilled water.

10. CALIBRATION

A characteristic feature of every conductivity cell is its K constant. Before displaying the result on the display the value is multiplied by the K constant value. The value of the K constant depends on the size of the electrodes' surface and the distance between them. **If the user keeps the cell clean, the K constant does not change.** In case of contamination of the surface of the electrodes, the K constant would change.

In order to prepare the meter for co-operation with the conductivity cell, it is essential to calibrate it for obtaining accurate results. Calibration may be performed without standard solution, by entering the value of the K constant of the cell given by the manufacturer to the meter's memory (we recommend this kind of calibration) or with use of standard solution with known conductivity – **to determine the K constant.**

The K constant is precisely determined by the cell manufacturer and using this value will be the most reliable.







In case of calibration performed by the user, fresh, accurately prepared standard solution is required. Additionally it has to be accurately thermostated to the temperature 25⁰C. If the conditions won't be kept the calibration may be burdened with error.



When using three cells, it is possible to store their characteristics under the $E1$, $E2$ or $E3$ symbols.

10.1. Calibration without standard solution

The meter has a possibility of calibration without the use of standard solution. In case of such a calibration it is necessary to know the K constant of the conductivity cell. This value may be given by the cell producer or may be determined using the **CC-401** meter after calibrating it in the standard solution.

In order to perform the calibration:

- in the measuring mode press the  button till displaying the screen with the value of K constant (pic.16);
- with the  ,  buttons choose the number of cell; ($E1$, $E2$, $E3$ symbols);
- press and hold the  button, till the **CAL** symbol appears on the display;
- with the  ,  buttons enter the value of K constant;

- press the  button and return to the mode of choosing the number of cell or enter the measuring mode by pressing the  button.

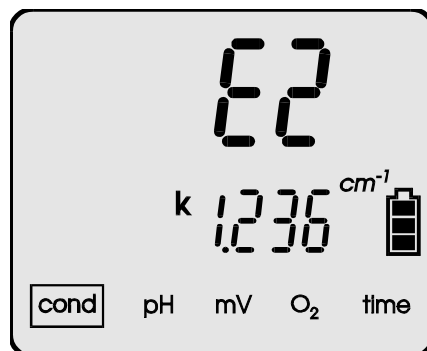

Pic.16.

10.2. Calibration with use of standard solution





The meter enables one-point calibration in the freely chosen standard solution. To decrease the error it is recommended to use solutions with a value close to the estimated value of measurement. It is required to use high quality standard solutions. The calibration is done in the actually chosen unit (chapter 13.1).

It is necessary to comply to the principles given below to obtain the exact results of calibration:

1. The temperature of standard solution should be equal to the reference temperature (the most often it is 25 °C).
2. New, unused standard solution should be applied.
3. The cell and electrodes of calibrated sensor should be clean and devoid of bubble of air.
4. The electrode holder should be used.

10.2.1. **Entering the value of standard solution**

To enter the value of standard solution:

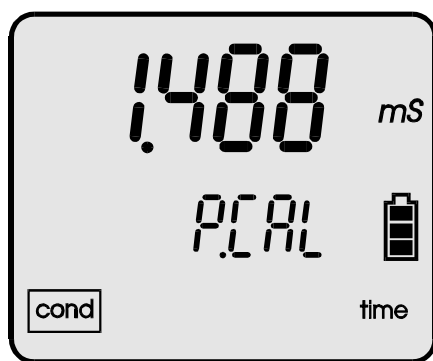

- choose the unit according to the point 8.1;
- in the conductivity measuring mode press the  button till the *P.L.A.L.* symbol appears in the lower row on the LCD (pic.17);
- with the  ,  buttons enter the value of standard solution in the upper row on the LCD;
- enter the measuring mode by pressing the  button.



Pic.17.

10.2.2. Calibration with automatic temperature compensation

It is necessary to:

- enter the value of standard solution (point 10.2.1);
- connect the conductivity cell and the temperature probe;
- immerse both of them in the standard solution, hold the conductivity cell at least 1 cm away from the bottom and walls of the vessel. The measuring cell should be filled up with the measured solution, there shouldn't be any air bubbles and the electrodes should be evenly moistened*;
- measure the temperature of solution and bring it to the introduced value of reference temperature;
- press and hold the  button until the **CAL** symbol appears on the display (pic.18);
- wait till the value stabilises and press . Blinking result informs about storing it in the memory. If the **Err** symbol displays, it is necessary to check the introduced value of the standard solution;
- exit the calibration mode by pressing .

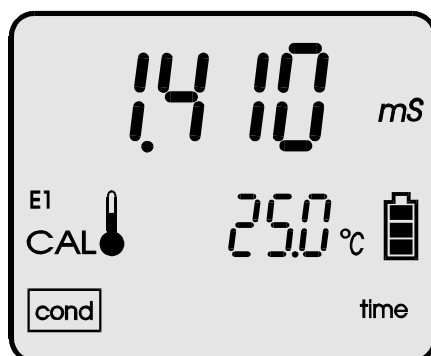







Pic.18.

The meter is calibrated and ready for the measurement.

* - air bubbles may be removed by moving the immersed cell. In order to make moistening of the electrodes easier, it is recommended to immerse the cell in distilled water with washing-up liquid, and then wash it in distilled water.

10.2.3. Calibration with manual temperature compensation

In order to calibrate the meter it is necessary to:

- turn the meter on with ;
- choose the conductivity measuring mode (chapter 8.1);
- disconnect the temperature probe and press the  ,  buttons simultaneously. In the lower line of LCD an introduced reference temperature value will appear;
- introduce the value of the standard solution (chapter 10.2.1);
- immerse the conductivity cell in the standard solution and hold it at least 1cm away from the bottom and walls of the vessel. The measuring cell should be filled up with the standard solution and shouldn't include any air bubbles, the electrode's surface should be evenly moistened*;
- measure the temperature of the standard solution with a lab thermometer and bring it to the introduced reference temperature;
- press and hold  till the **CAL** symbol (pic.19) appears on the display.
- wait till the result stabilises and press  . Blinking result informs about storing it in the memory. If **Err** symbol displays it is necessary to check the introduced value of the standard solution.
- exit the calibration mode by pressing  .

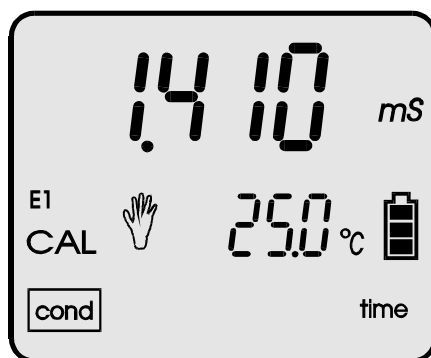



Pic.19

The meter is calibrated and ready for the measurement.

* - air bubbles may be removed by moving the immersed cell. In order to make moistening of the electrodes easier, it is recommended to immerse the cell in distilled water with washing-up liquid, and then wash it in distilled water.

11. CONDUCTIVITY MEASUREMENT

11.1. Measurement without temperature compensation

An accurate conductivity measurement should be made without the temperature compensation. The measured solution should be brought to the reference temperature value introduced earlier. When controlling, it is possible to use the temperature probe. In case of work without the temperature probe it is necessary to introduce the temperature value with the  ,  buttons.

In order to make a measurement without the temperature compensation:

- connect the conductivity cell and the temperature probe to the connectors **F1** and **t** respectively (pic.2);
- turn the meter on with .
- choose the conductivity measuring mode and the unit (point 8.1);
- if the conductivity cell wasn't calibrated, calibrate it according to the chapter 10;
- place both probes in the measured solution, the conductivity cell can't touch the walls and the bottom. The measuring cell should be filled up with the standard solution and shouldn't include any air bubbles, the electrode's surface should be evenly moistened*;
- bring the temperature of the measured solution to the value of the reference temperature.
- read the result after it has stabilised (pic.20).

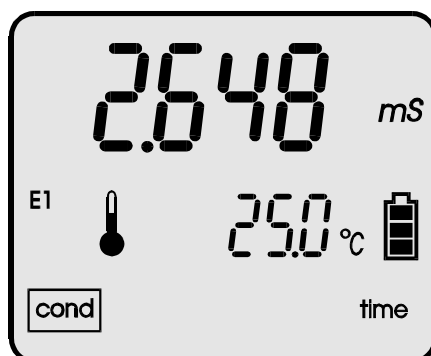

Pic. 20.

* - air bubbles may be removed by moving the immersed cell. In order to make moistening of the electrodes easier, it is recommended to immerse the cell in distilled water with washing-up liquid, and then wash it in distilled water.

11.2. Measurement with automatic temperature compensation



In order to make a measurement with automatic temperature compensation:

- connect the conductivity cell and the temperature probe to the connectors **F1** and **t** respectively (pic.2);
- turn the meter on with  button.
- choose the conductivity measuring mode and the unit (point 8.1);
- if the conductivity cell wasn't calibrated, calibrate it according to the chapter 10;
- check or change the value of the reference temperature and the α coefficient;
- place both probes in the measured solution, the conductivity cell can't touch the walls and the bottom. The measuring cell should be filled up with the standard solution and shouldn't include any air bubbles, the electrode's surface should be evenly moistened*;
- wait till the result stabilises and read it (pic.21).



Pic.21.

Notice: in case of exceeding the range of temperature compensation the result starts blinking even though the conductivity measuring range has not been exceeded.



Displaying of the  symbol instead of  next to the value informs that the temperature probe is broken.



* - air bubbles may be removed by moving the immersed cell. In order to make moistening of the electrodes easier, it is recommended to immerse the cell in distilled water with washing-up liquid, and then wash it in distilled water.

11.3. Measurement with manual temperature compensation

Measurement with manual temperature compensation may be made in stable work conditions, e.g., during measurements in laboratory, especially with use of thermostat, or in case of the temperature probe damage. Disconnecting of the temperature probe switches the meter to manual temperature compensation.

In case of measurement with manual temperature compensation:

- connect the conductivity cell to the **F1** connector (pic.2);
- turn the meter on with  button.
- choose the conductivity measurement and the unit (point 8.1);
- if the conductivity cell wasn't calibrated earlier, calibrate it according to chapter 10;
- control or change the value of the reference temperature and the coefficient α ;
- place the probe in the measured solution, the conductivity cell can't touch the walls and bottom. The measuring cell should be completely filled up with the standard solution and shouldn't include any air bubbles, the electrode's surface should be evenly moistened*;
- measure the temperature of the solution and introduce its value with the ,  buttons.
- after stabilisation read the result (pic.22).

Notice: pressing of ,  buttons simultaneously sets the temperature to 25 °C.



Pic.22.

* - air bubbles may be removed by moving the immersed cell. In order to make moistening of the electrodes easier, it is recommended to immerse the cell in distilled water with washing-up liquid, and then wash it in distilled water.

12. SALINITY AND TOTAL DISSOLVED SOLIDS MEASUREMENT

Salts and minerals dissolved in natural water influence the conductivity, which in principle is proportional to the quantity of dissolved substances. This dependence enables, after certain calculations, to determine the salinity of the measured solution in concentration units (g/l or %), or to determine the TDS (Total Dissolved Solids). The received values are always approximate and the total accuracy depends on the way of making the calculations, concentration of the measured solution and its temperature. In most salinity meters a simplification is used, that dependence between conductivity and salinity in the solution is linear in the whole measuring range. Usually a 0.5 coefficient is used, the conductivity result in mS/cm is multiplied by this coefficient and the result of salinity is received in g/l, e.g., if the conductivity value is 2 mS/cm the salinity is 1g/l. In practice the dependence between conductivity and salinity isn't linear and the conversion coefficient is changing together with the concentration and temperature. Table 1 shows the dependence between conductivity and actual salinity of NaCl solution in temperature 25 °C and values of salinity counted for constant coefficient 0.5. This comparison shows that using a constant coefficient for greater concentrations introduces significant error.

Table 1.

Conductivity (mS/cm)	Actual salinity (g/l)	Salinity (g/l) Counted for coefficient = 0.5	Error (%) by using the coefficient = 0.5
1.00	0.495	0.500	0.01
2.00	1.006	1.000	0.60
4.00	1.976	2.000	1.21
10.00	5.400	5.000	7.40
30.00	18.174	15.000	17.46

In CC-401 microcontroller takes into consideration the actual dependence between the conductivity and salinity what greatly reduces the error. There is a possibility of counting the salinity in NaCl or KCl, because the dependence for this two salts is a bit different.

The results are more accurate for homogeneous solutions (NaCl, KCl). Concentration of salts mixture with unknown composition in most cases is counted to NaCl. The usefulness of water for home or industry is usually checked by determining of TDS. In order to use the conductivity readout for determining the TDS it is necessary to specify the W_{TDS} coefficient, which enables automatic conversion after introducing it to the meter's memory. To determine the W_{TDS} coefficient it is necessary to specify the weight of dissolved substances. The laboratory method of determining the dissolved solids content consists in taking a given volume of water, evaporating the filtered sample, drying it to constant weight in temperature $103\div 105^{\circ}\text{C}$, weighting and counting in volume ratio (mg/dm^3). The received weight is lower than total dry mass in water because apart from the dissolved solids it contains also undissolved substances which are removed by filtering before evaporating. It is possible to determine the approximate Total Dissolved Solids content using the conductivity readout on the assumption that the salt's composition in the taken samples is not changing significantly.

12.1. Salinity measurement with conversion to NaCl or KCl

The measurement of salinity with conversion to NaCl or KCl content should be done as follows:

- choose the salinity measurement with conversion to NaCl or KCl content according to chapter 8.1;
- choose the unit (g/l or %);
- then act as during conductivity measurement (chapter 11);
- read the result after it has stabilised.

12.2. Determining the W_{TDS} coefficient

For salinity measurement with conversion to TDS content it is necessary to determine the W_{TDS} coefficient and enter it to the meter's memory. In order to do so it is necessary to make the conductivity measurement of the tested water with exactly given volume or weight, determine the Total Dissolved Solids in traditional way and then count the coefficient according to the formulas given below.

1. If the result is to be displayed in g/l:

$$W_{TDS} = \frac{TDS}{\gamma}$$

where:

W_{TDS} - TDS coefficient

TDS - Total Dissolved Solids in g/l;

γ - conductivity of the sample in mS/cm;

Caution: the TDS value should be counted to volume of sample which amounts to 1l.

2. If the result is to be displayed in % of weight concentration:

$$W_{TDS} = \frac{TDS}{\gamma}$$

where:

W_{TDS} - TDS coefficient

TDS - Total Dissolved Solids in g/kg;

γ - conductivity of the sample in mS/cm;

Caution: the TDS value should be counted to weight of the sample which amounts to 1kg.

12.3. Salinity measurement with conversion to TDS

The measurement of salinity with conversion to TDS should be done as follows :

- according to chapter 8.2 introduce the W_{TDS} coefficient;
- choose the measurement of salinity with conversion to TDS and the displayed unit (g/l or %);
- then act as during conductivity measurement.
- after it has stabilised, read the result in chosen units (g/l or %).

13. SIMPLIFIED WAY OF DETERMINING THE α COEFFICIENT

The knowledge of α coefficient has a crucial significance during measurements in temperatures different than the reference temperature. This coefficient is changing together with the temperature and concentration. Table 2 contains values of α coefficient in 25 °C for a few compounds with determined weight concentration.

Table 2.

substance	weight concentr.	α coefficient
HCl	10 %	1.56
KCl	10 %	1.88
H ₂ SO ₄	50 %	1.93
NaCl	10%	2.14
HF	1.5 %	7.20
HNO ₃	31 %	1.39

In the table 3 there are given rough values of α coefficient for KCl and NaCl depending on the temperature and concentration of the measured liquid.

Table 3.

Temp. °C	Temperature coefficient α			
	KCl solution			Saturated NaCl
	0,01M	0,1M	1,0M	
5	2,68	2,68	2,39	2,77
10	2,45	2,36	2,20	2,53
15	2,27	2,19	2,04	2,38
20	2,11	2,06	1,89	2,21
25	1,91	1,86	1,75	2,03
30	1,80	1,77	-	1,91

Use the value of the α coefficient determined for the reference temperature to which the meter calculates the result.

It may be assumed that the α coefficient is constant when the temperature differs less than ± 5 °C from the reference temperature.

For more significant differences between the measurement and the reference temperatures the value of the α coefficient may be determined according to the description below:

1. Bring the measured solution to the reference temperature T_R and measure its conductivity (G_{TR}).
2. Change the solution temperature T_X to the value in which the measurement will be made.
3. Turn the meter to manual temperature compensation by disconnecting the temperature probe.
4. Enter the value of reference temperature T_R with the keyboard.
5. Measure the conductivity of the solution again. This value will be different than in T_R temperature (G_{TX}).

Determine the α coefficient using the formula:

$$\alpha = \frac{G_{TR} - G_{TX}}{G_{TR} (T_R - T_X)} \times 100 (\%/^{\circ}\text{C})$$

where: T_R - reference temperature value in $^{\circ}\text{C}$
 T_X - value of the changed temperature in $^{\circ}\text{C}$
 G_{TR} - conductivity measured in ref. Temperature T_R .
 G_{TX} - conductivity measured in temperature T_X

Now, the α coefficient is determined for the reference temperature T_R and the measurement temperature T_X .

During measurements in temperatures different than the reference temperature it is necessary to introduce the calculated α coefficient value for the measurement temperature.

Caution: In case when the T_R reference temperature is coming to 25°C the formula mentioned above is:



$$\alpha = \frac{G_{25} - G_{TX}}{G_{25} (25 - T_X)} \times 100 (\%/^{\circ}\text{C})$$

where: T_X - value of the changed temperature in $^{\circ}\text{C}$
 G_{25} - conductivity measured in 25°C .
 G_{TX} - conductivity measured in temperature T_X



III. TEMPERATURE MEASUREMENT

14. TEMPERATURE MEASUREMENT

The temperature measurement is made as follows:

- by pressing the  button switch the meter on;
- connect the temperature probe to the Chinch connector, on the display the  symbol will be displayed;
- put the temperature probe to the measured solution;
- wait till the value stabilises and read the result in the lower row of numbers.



The meter cooperates with the Pt-1000 probe. Depending on its class the accuracy of the measurement changes.

CAUTION: break in the circuit of the temperature probe switches the meter to the manual temperature compensation mode. It is signalled by changing of the  symbol to the  symbol. On the display there is shown the value of the temperature entered by the user.

Blinking -50°C value while making measurement in positive temperature informs about short circuit in the temperature probe.

IV. OTHER

15. CLOCK WITH DATE

After choosing the **time** mode with  button the meter will display the actual time. Pressing of  displays interchangeably: the date, backlight mode, auto switch off time and number of the software version.

15.1. Clock

The time is displayed in two rows on the display. In the upper one hours and minutes are displayed and the lower one displays seconds. The way of changing hours is described below.



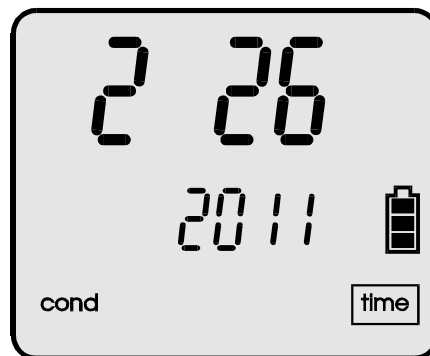

15.2. Date

The date is displayed as follows: Month – Day – Year. (Pic.23). In the upper row the month and day are displayed and in the lower row - the year.







Pic.23.

15.3. Setting time and date

The mode of setting currently displayed parameter (hour or date) is entered by pressing and holding . The position which we are going to change starts blinking, the value can be changed with the  ,  buttons. Pulsating position is chosen by pressing  button shortly. There is no possibility of setting seconds, they reset after the setting mode is left. Press the  button to leave the setting mode.

15.4. Auto switch off function

In order to choose the screen of setting the auto switch off function it is necessary to press the  button in the **time mode** till the **Auto OFF** (Auto OFF) symbol displays (Pic. 24). The lower row displays the time of switching off in minutes (the time is counted from the last press of any button). The value is changed with the  ,  buttons. If after choosing 1 minute the button  is pressed, instead of numbers a --- symbol displays. The auto off function is deactivated. Return to the **time** mode after pressing the  button.

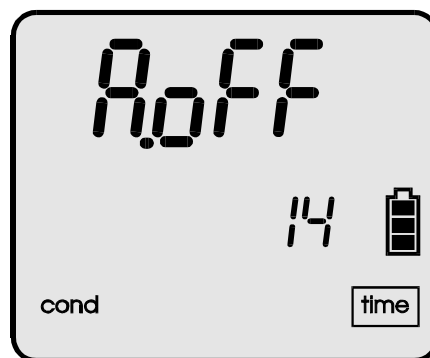

Pic.24.

The auto switch off function is active only in case of working on rechargeable battery. This function is deactivated during calibration, collecting series of measurements and in case of working with a power adapter.



15.5. The LCD backlight mode

In the **time** mode press  till a *LEd* sign displays in the upper row of the LCD (Pic.25). In the lower row an *off*, *Auto* or *on* parameter will be displayed.

- *off* the backlight is switched off;
- *Auto* mode of automatic switching on of the backlight for 30 seconds (in the calibration mode 5 minutes) after each use;
- *on* the backlight is always on.





Pic.25.

With the  ,  buttons choose the backlight mode.

Return to the **time** mode after pressing the  button.



15.6. The brightness control

Controlling brightness of the backlight is especially important during the field work. Decreasing the brightness to 50% makes the work time on one set of batteries two times longer, with brightness which is sufficient for work.

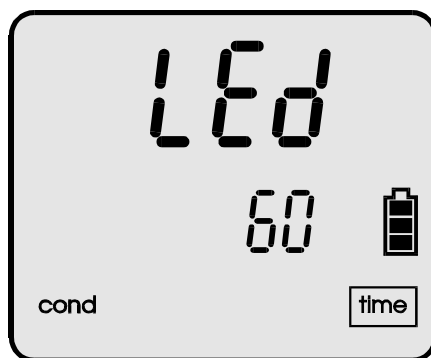
While choosing the backlight mode (point 15.5) it is possible to control brightness (only for the *Auto* and *on* mode) by pressing the  button shortly. Instead of *Auto* or *on* parameter the value of brightness in % displays. With  ,  buttons it is possible to set the brightness value from 10 ÷ 100%, every 10%.



Pic.26

Return to the backlight mode by pressing the  button, and to the **time** mode by pressing the  button.

15.7. Readout of the software version number

In the **time** function press the  button till there is a screen displayed, as in the picture below (Pic.27). The upper row displays the software version number and the lower row shows the kind of internal power source to which the meter is prepared:

- Accu* - powered by two internally rechargeable R6/AA batteries;
- bAtt* - powered by two standard R6/AA batteries.

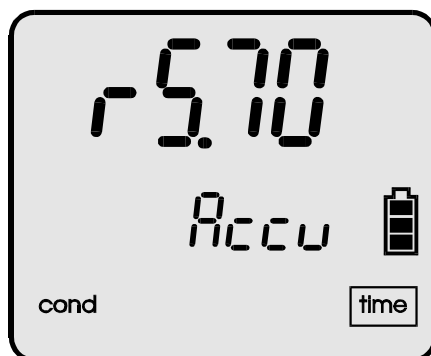

Pic.27.

Return to the **time** mode after pressing the  button.

16. STORING AND READOUT OF THE RESULTS

The meter enables storing of 4000 results of the actually measured function. The results are stored in EEPROM memory, which is non-volatile, so the data isn't lost even after complete lack of power. Before starting work it is necessary to choose the parameters of storing or readout of the stored results.

16.1. Parameters of storage and readout from the memory

The parameters are changed in the readout mode, which is entered from every measuring function by pressing and holding the  button, until the number of last stored result shows. This number is displayed on turns with the stored result.



Before storing, choose the way of collecting results: on request or automatically in series, and also the way of displaying the result.

Next presses of the  button show screens with following parameters which may be changed:

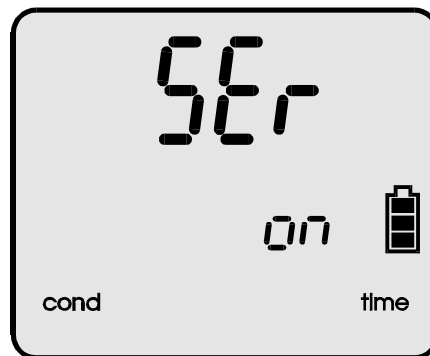
- a. **SEr** - collecting series or single results.



Pic.28.

With  ,  buttons choose in the lower row *on* or *off* symbol. (Pic.28).

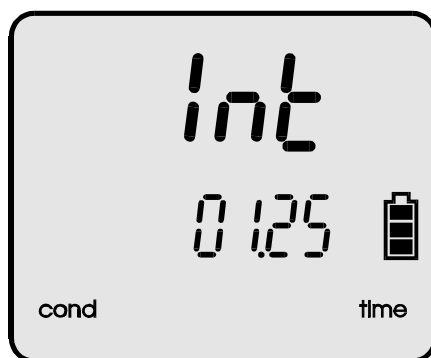

Choosing *on* activates automatic storage of the results and *off* -single storage, after every pressing of  button.

b. *int* - time interval during series taking (Pic.29).



Pic.29.

The length of the time interval is displayed in the lower row of digits, and the informative symbol *int* in the upper row.

The  ,  buttons are used for setting time in minutes and seconds. The shortest interval is 1 second and the longest - 60 minutes. Holding the button increases change rate (repetition).

In case of setting the *SER* parameter to *off*, the position *int* is not displayed.

c. *ALL* - the way of displaying stored results;

on - successively: the number of the sample, the result, time and date of storing the result.

off - successively: the number of the sample and the result.

Changing with  ,  buttons.

Return to the results readout display after pressing the  button.

Exit from the readout mode after pressing the  button.

16.2. Memorising single readouts



If storing of single results has been chosen according to previous section, every press of the  button stores the result. The results are stored as the next ones after the latest stored. In case of checking the results stored earlier and not returning to the last one, the results won't be deleted and the value will be stored under the first empty position. In case of storing the result beginning with the chosen number, first delete the results starting from this particular number (as described in the point

16.5) and next start memorising the results by pressing the  button. While memorising the result, its number will be displayed for a moment.



If after pressing the  button instead of a number the *End* sign is displayed, it informs that the maximal number of results has been reached.

16.3. Collecting measuring series

There is a possibility to store series of measurements in the meter's memory. It is necessary to:



- choose the way of collecting the results serially (point 16.1a);
- enter the time interval (point. 16.1b);
- delete the stored results starting from the chosen one (p 16.5);
- return to the measuring mode by pressing the  button.
- with the  button choose the function of which results are going to be stored.
- with the  button start taking series. The measurements will be stored starting from the first free number.



Collecting series is signalised by blinking frame around the symbol of the function of which results are being stored.

Before each time the result is memorised, the number of the measurement will be displayed for a moment. Collecting series may be stopped by pressing the  or the  button or by filling up all the memory capacity. The next series can be started unless the memory capacity has been filled up.

16.4. Reviewing the results

Reviewing of stored results is started in the measuring mode, by pressing and holding the  button until the number of the last stored result displays on turns with it's value.





Each press of the  or  button shows the next or previous number and result with time and date **depending on which parameter of the ALL function has been chosen** (p 16.1.c).

In this mode the ,  buttons function with repetition and after holding them the numbers are changing with increasing rate till they stop at the highest or lowest number.

The reviewing mode is left by pressing the  button.



16.5. Deleting stored results

In order to delete stored results:

- press and hold the  button;
- with buttons ,  set the number of the measurement from which we want to start deleting results from the memory;
- press and hold the  button; it will delete results from the chosen one to the last one remembered. Instead of results there will be --- sign displayed, what confirms deleting;
- to exit the reviewing mode press the  button.

In case of filling up the memory capacity, further results won't be stored. To store new results it is necessary to delete the previous ones acting as it is described above. In case of deleting all the results from the memory, it should be started from the first number.

17. POWER, REPLACING THE RECHARGEABLE BATTERY

The meter is powered with 2 x R6 rechargeable batteries (AA) or stabilised power adapter (6V). The adapter should be connected with the **P** connector (pic.2). The batteries are necessary in order to keep the clock going. The  symbol in the lower right corner of the LCD informs about the condition of the battery. Blinking  symbol informs about the necessity of charging. If the voltage falls below the minimal value, the meter will switch off. Connecting the power adapter starts the process of charging the batteries, it is signalled by blinking elements in the  symbol. When this symbol starts lighting continuously, it informs that the battery is fully charged.

During the charging process the meter can normally work.

To replace the batteries it is necessary to undo two screws in the lower wall of the meter, pull out the container with batteries and replace them, paying attention to insert the batteries properly. The next thing is to put the battery back into the meter and mount the wall. The wall has a sealing ring on the edge. While closing the meter, it is very important to pay attention to it - the ring should be put inside the housing in the whole perimeter. Next, do the screws till the moment of resistance (not too hard). Leaving the wall improperly screwed may cause the meter's inundation. This kind of failure is not repaired under the warranty conditions.

18. CO-OPERATION WITH A PC

Connecting the meter with a PC enables storing the data directly on the computer, what makes a possible number of results to store unlimited. The PC should be equipped with a serial RS-232 connector. For transmission a special software prepared by our company may be ordered. The software is delivered on a CD. After inserting the CD to a drive the installation program starts automatically. It is necessary to follow the given instructions.

In the upper wall of the meter an RS connector is placed, what enables connecting with a PC using a 4xx-PC cable. The meter may also be connected with a PC equipped with a USB connector, in order to make it an RS-232/USB converter is required (available as an optional equipment).

After connecting, turn the meter and the PC on and launch the transmission software. In menu SETUP / PORT choose USB or COMx, (x is the number of the serial port - usually it is COM1). Next, choose the mode of cooperation with the meter. We have two options available:

- "Collect series" is used for collecting results of a current measurement. After choosing this option a window with the result of a current measurement displays. Only the elements which are marked in the field "Send" will be collected and stored. It is necessary to set the number of measurements which are to be stored and the time intervals. On the basis of this data the software will count the time of collecting the whole series. The series are stored in a temporary file. In case of lack of power the collected data will be stored in a file "NoNamexx". The collecting is started by pressing the "Collect" button.
- "Download data from memory" enables sending the chosen part or whole of the data stored in the meter's memory to a file. In option "Collect" mark the data that are to be sent. The transfer is started by pressing the button "Download".

Caution: the meter and the PC should be switched on **after** connecting the cable.

19. TECHNICAL DATA

THE CONDUCTIVITY MEASUREMENT:

Ranges	Resolution	Accuracy (±1 digit)	Frequency
0.000 ÷ 19.999 μS/cm	0.001 / 0.01 μS/cm	±0.1 %	100 Hz
2 0.00 ÷ 199.99 μS/cm	0.01 / 0.1 μS/cm	±0.1 %	1 kHz
2 00.0 ÷ 1999.9 μS/cm	0.1 / 1 μS/cm	±0.1 %	2 kHz
2.000 ÷ 19.999 mS/cm	0.001 / 0.01 mS/cm	±0.1 %	5 kHz
2 0.00 ÷ 199.99 mS/cm	0.01 / 0.1 mS/cm	±0.25 %	10 kHz
2 00.0 ÷ 1999.9 mS/cm	0.1 / 1 mS/cm	±0.25 %	10 kHz

* Accuracy given for the end value of the range.

Ranges of frequency changes were given for constant $K = 1$. For other values of the K constant the values will change proportionally to changes of this constant.

TEMPERATURE COMPENSATION: manual/automatic
 COMPENSATION RANGE: $-5.0 \div 70.0$ °C
 K CONSTANT RANGE: $0.010 \div 19.999$ cm⁻¹
 α COEFFICIENT RANGE: $0.00 \div 10.00$ %/ °C
 TDS COEFFICIENT RANGE: $0.20 \div 1.00$
 MEASURING RANGE KCl: $0 \div 200$ g/l
 MEASURING RANGE NaCl: $0 \div 250$ g/l
 PROBE CALIBRATION: 1- point
 1. by entering the K constant of the probe
 2. using the calibration solution

THE TEMPERATURE MEASUREMENT:

Range	Resolution	Accuracy* (±1 digit)
$- 50.0 \div 199.9$ °C	0.1 °C	±0.1 °C

* accuracy of the meter. The final accuracy of the measurement depends on the accuracy of the applied PT-1000 probe

TEMPERATURE PROBE: platinum resistor Pt-1000

ACCURACY OF THE PROBE IN RANGE: $0 \div 100$ °C:
 FOR PT1000B RESISTOR: ±0.8 °C
 FOR PT1000¹/₃B RESISTOR: ±0.27 °C

OTHER:

MEMORY CAPACITY:	4000 results
OPERATING TEMPERATURE:	-5 ÷ 45 °C
POWER:	2 x AA Rechargeable Battery NiMH Stabilised power adapter 6V/500 mA
POWER CONSUMPTION:	
Backlight 0%	70 mW
Backlight 100%	180 mW
Charging the batteries max.	2.4W
SCREEN:	LCD 55 x 45 mm
DIMENSIONS:	149 x 82 x 22 mm
WEIGHT:	260 g (with battery)

20. EQUIPMENT

Standard set:

1. ECF-1 conductivity cell (K constant=0.45);
2. Pt-1000B temperature probe (standard);
3. Plastic container for the meter, the sensor and the temperature probe;
4. 6V/500mA power adapter;
5. Users manual with warranty.

Additional equipment:

1. 4XX-PC cable;
2. RS-232/USB converter;
3. Software for collecting large number of data on the PC;
4. Pt-1000 1/3B temperature probe of higher accuracy;
5. Conductivity cells for different conductivity ranges.

WARRANTY

The ELMETRON company ensures a 24-month warranty for the conductivity / salinity meter **CC-401** number:

.....

In case of damage the producer will repair the meter within 14 days from the day of delivery.

The warranty doesn't cover the damages caused by usage not in conformity with the user's manual, using wrong power adapter, mechanical damages and damages caused by repairs made by unauthorised persons.

The conductivity cell has a separate warranty.

NOTICE: Before sending the meter to us please contact the firm by phone or email.

When sending the meter, the conductivity cell, the temperature probe and the power adapter should be also included.

Date of production.....

Date of sale.....

Date of warranty expiry.....

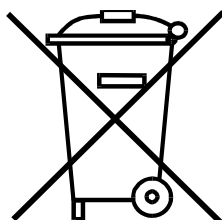

ELMETRON[®] Sp. j.

41-814 Zabrze; Witosa 10; POLAND
tel. (+48) 32 2738106 fax (+48) 32 2738114
www.elmetron.com.pl
e-mail: handel@elmetron.com.pl